

PIUSI MP

EN. PIUSI MP air-operated diaphragm pumps are designed to assure the utmost reliability and highest performance levels. The sturdy central technopolymer body, the suction, the lateral half-shells and delivery manifolds use the highest quality thermoplastic diaphragms. This diaphragm makes it possible to transfer diesel, water and chemicals such as AdBlue and antifreeze.

The pneumatic circuit is a guarantee of safety and the construction principle makes Piusi MP pumps particularly suitable for severe duty conditions or operation in potentially explosive atmospheres (ATEX certification for zone 2).

Piusi MP pumps are self-priming and can run dry without damage; they also allow fine tuning of speed without pressure loss.

ES. Las bombas neumáticas de membrana PIUSI MP garantizan máxima fiabilidad y altas prestaciones. El robusto cuerpo central de tecnopolímero, los medios cuerpos laterales y los colectores de aspiración e impulsión en polipropileno, junto con las membranas de alta calidad en materiales termoplásticos; permiten el trasiego de diesel, de agua y de líquidos químicos como AdBlue o anticongelantes.

Por la seguridad del circuito neumático y por su diseño avanzado, las bombas Piusi MP están especialmente indicadas para aplicaciones severas o atmósferas potencialmente explosivas (certificación ATEX para zona 2).

Las bombas Piusi MP son autocebantes, pueden funcionar en seco sin dañarse y permiten hacer una regulación precisa de la velocidad sin pérdidas de presión.

RU. Пневматические мембранные насосы PIUSI MP разработаны для обеспечения максимальной надежности и высокой эффективности. Прочный центральный корпус из технической пластмассы, полипропиленовые всасывающие и нагнетательные коллекторы и боковые полукорпуса, применение высококачественных мембран из термопластов позволяет перекачивать дизельное топливо, воду, химические жидкости, таких как AdBlue или антифризов.

Пневматический контур – гарантия бесперебойной работы и по своему принципу конструирования насосы Piusi MP в первую очередь подходят для применения в сложных условиях или потенциально взрывоопасной среде (сертификация ATEX для 2 зоны).

Насосы Piusi MP – самозаливающиеся, могут работать без жидкости без повреждений, также позволяют выполнять точную настройку скорости без потери напора.

DIMENSIONS

PIUSI MP 130

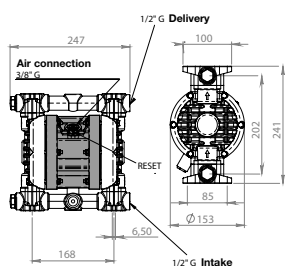

PIUSI MP 140

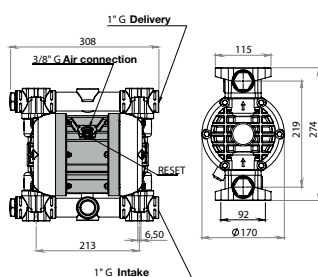

PIUSI MP 180

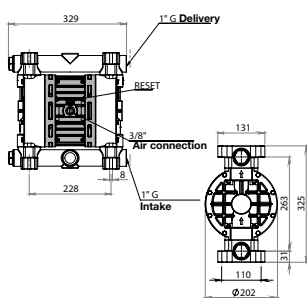

PIUSI MP 190

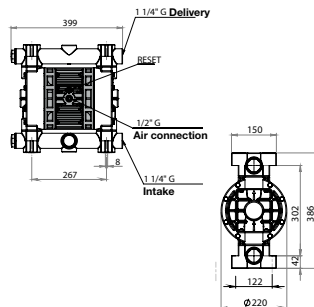

PRODUCTS' RANGE WEIGHT AND PACKAGING

Code	Weight		Packaging		
	kg	lbs	mm	inch	pcs/box
F00208P00	3,6	7,9	220x310x320	8,7x12,2x12,6	1
F00208P20	5	11	240x380x350	9,4x15x13,8	1
F00208P30	7,5	16,5	270x390x400	10,6x15,4x15,7	1
F00208P40	12	26,5	290x470x460	11,4x18,5x18,1	1

PRODUCTS' RANGE TECHNICAL DATA

Code	Description	Fluids	Pump Body	In/out	Flow Rate
		type			
F00208P00	PIUSI MP130	DWUA	Polypropylene	1/2" G	50
F00208P20	PIUSI MP140	DWUA	Polypropylene	1" G	100
F00208P30	PIUSI MP180	DWUA	Polypropylene	1" G	150
F00208P40	PIUSI MP190	DWUA	Polypropylene	1" 1/4" G	220



Flow-rate
up to
220 l/min
(up to 58,1 gpm)



PIUSI MP 130

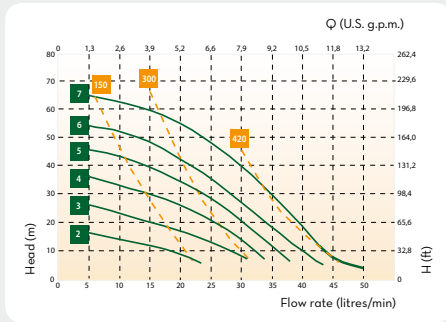

PIUSI MP 140

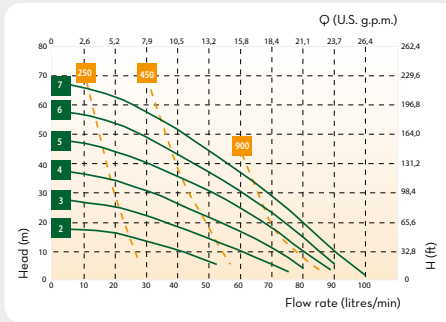

PIUSI MP 180

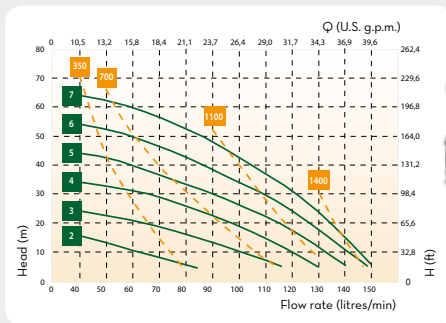

PIUSI MP 190

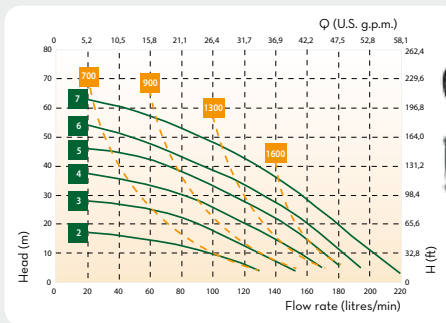

— Air supply pressure (bar)
— Air consumption NI/min

Our product complies with the following marking ATEX (zone 2). The Equipment user is responsible for classifying its area of use.

II	3/3	GD	c	IIB	T4
GROUP	CATEGORY	TYPE OF EXPLOSIVE ATMOSPHERE	PROTECTION METHOD	GAS CLASS	TEMPERATURE CLASS

AVAILABLE ACCESSORIES



Membrane type	Diaphragm Air side/Fluid Side	Balls	Ball seats*	O-Ring*	Intake / Delivery connection	Air connection	Max self-priming capacity	Max head**	Max air supply pressure	Max diameter of passing solid
							m	m	bar	mm
double	PTFE/ Hytrel	PTFE	Polypropylene	PTFE	G 1/2"f	G 3/8"f	5	70	7	4
double	PTFE/ Hytrel	PTFE	Polypropylene	PTFE	G 1"f	G 3/8"f	6	70	7	4
double	PTFE/ Hytrel	PTFE	Polypropylene	PTFE	G 1"f	G 3/8"f	5	70	7	4
double	PTFE/ Hytrel	PTFE	Polypropylene	PTFE	G 1"1/4 f	G 1/2"f	6	70	7	4

* On request we can provide membranes, balls, ball seats and O Rings in different materials ** The value depends on the configuration of the pump

- DISPENSERS
- PUMPS
- METERS
- NOZZLE METERS
- NOZZLE
- SPECIAL EQUIPMENTS
- FLUID MONITORING
- HOSE REEL
- FILTERING
- ACCESSORIES