

PIUSI MA for Oil and Diesel

EN. PIUSI MA air-operated diaphragm pumps are designed to assure the utmost reliability and highest performance levels. The sturdy central polypropylene body, the lateral half-shells and aluminium or polypropylene suction and delivery manifolds plus the use of high quality NBR diaphragms make it possible to transfer fluids with high apparent viscosities, even when contaminated with suspended solids as in the case of spent oil.

The pneumatic circuit is a guarantee of safety and the construction principle makes Piusi MA pumps particularly suitable for severe duty conditions or operation in potentially explosive atmospheres (ATEX certification for zone 2).

Piusi MP pumps are self-priming and can run dry without damage; they also allow fine tuning of speed without pressure loss.

ES. Las bombas neumáticas de membrana PIUSI MA garantizan máxima fiabilidad y altas prestaciones. El robusto cuerpo central de polipropileno, los medios cuerpos laterales de aluminio o polipropileno, junto con las membranas de alta calidad en NBR; permiten el trasiego de líquidos de alta viscosidad aparente, incluso con sólidos en suspensión como en el caso del aceite usado.

Por la seguridad del circuito neumático y por su diseño avanzado, las bombas Piusi MA están especialmente indicadas para aplicaciones severas o atmósferas potencialmente explosivas (certificación ATEX para zona 2).

Las bombas Piusi MA son autocebantes, pueden funcionar en seco sin dañarse y permiten hacer una regulación precisa de la velocidad sin pérdidas de presión.

RU. Пневматические мембранные насосы PIUSI MA разработаны для обеспечения максимальной надежности и высокой эффективности. Прочный центральный корпус из полипропилена, алюминиевые или полипропиленовые всасывающие и нагнетательные коллекторы и боковые полукорпуса, применение высококачественных мембран из БНК обеспечивает перекачку жидкости с высокой динамической вязкостью, в том числе и при наличии таких твердых взвесей, как отработанное масло.

Пневматический контур – гарантия бесперебойной работы и по своему принципу конструирования насосы Piusi MA в первую очередь подходят для применения в сложных условиях или потенциально взрывоопасной среде (сертификация ATEX для 2 зоны).

Насосы Piusi MP – самозаливающиеся, могут работать без жидкости без повреждений, также позволяют выполнять точную настройку скорости без потери напора.

DIMENSIONS

PIUSI MA 130

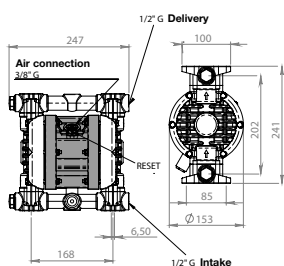

PIUSI MA 140

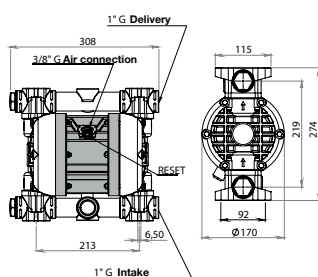

PIUSI MA 180

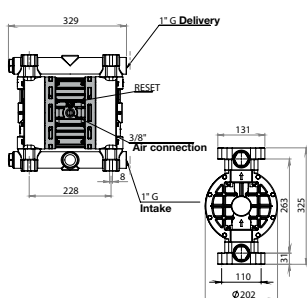

PIUSI MA 190

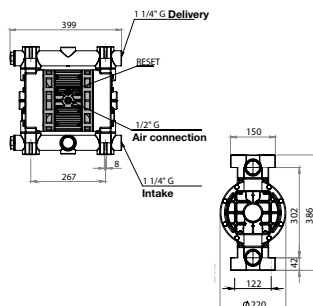

PRODUCTS' RANGE WEIGHT AND PACKAGING

Code	Weight		Packaging		
	kg	lbs	mm	inch	pcs/box
F00208A00	4	8,8	220x310x320	8,7x12,2x12,6	1
F00208P10	5	11	240x380x350	9,4x15x13,8	1
F00208A10	8,2	18,1	270x390x400	10,6x15,4x15,7	1
F00208A20	16	35,3	290x470x460	11,4x18,5x18,1	1

PRODUCTS' RANGE TECHNICAL DATA

Code	Description	Fluids	Pump Body	In/out	Flow Rate
		type			l/min
F00208A00	PIUSI MA130	D	Aluminium	1/2" G	50
F00208P10	PIUSI MA140	D	Polypropylene	1" G	100
F00208A10	PIUSI MA180	D	Aluminium	1" G	150
F00208A20	PIUSI MA190	D	Aluminium	1" 1/4" G	220



Flow-rate
up to
220 l/min
(up to 58,1 gpm)



PIUSI MA 130

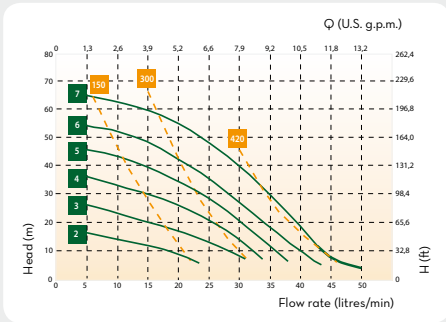

PIUSI MA 140

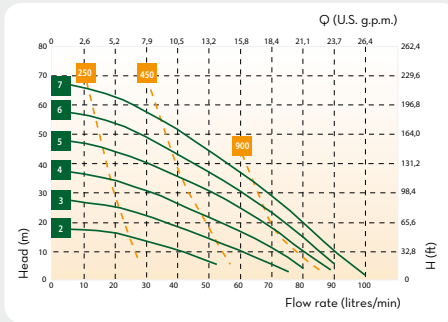

PIUSI MA 180

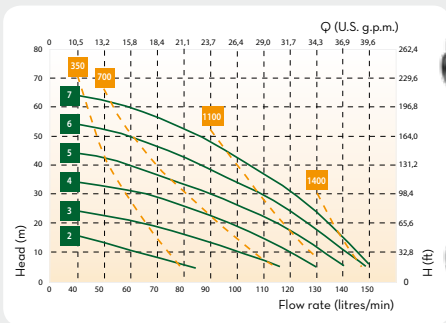

PIUSI MA 190

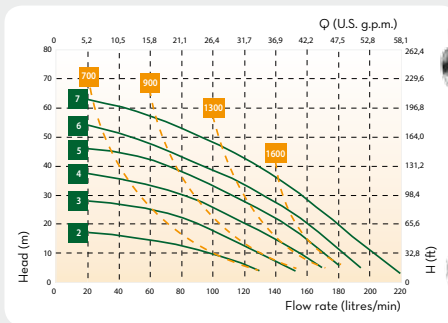

— Air supply pressure (bar)
— Air consumption NI/min

Our product complies with the following marking ATEX (zone 2). The Equipment user is responsible for classifying its area of use.

II	3/3	GD	c	IIB	T4
GROUP	CATEGORY	TYPE OF EXPLOSIVE ATMOSPHERE	PROTECTION METHOD	GAS CLASS	TEMPERATURE CLASS

AVAILABLE ACCESSORIES



Membrane type	Diaphragm	Balls	Ball seats*	O-Ring*	Intake / Delivery connection	Air connection	Max self-priming capacity	Max head**	Max air supply pressure	Max diameter of passing solid
							m	m	bar	mm
single	NBR	NBR	Aluminium	NBR	G 1/2"f	G 3/8"f	5	70	7	4
single	NBR	NBR	Polypropylene	NBR	G 1"f	G 3/8"f	6	70	7	4
single	NBR	NBR	PPS-V	NBR	G 1"f	G 3/8"f	5	70	7	4
single	NBR	NBR	PPS-V	NBR	G 1"1/4 f	G 1/2"f	6	70	7	4

* On request we can provide membranes, balls, ball seats and O Rings in different materials ** The value depends on the configuration of the pump

DISPENSERS
PUMPS
METERS
NOZZLE METERS
NOZZLE
SPECIAL EQUIPMENTS
FLUID MONITORING
HOSE REEL
FILTERING
ACCESSORIES