



MB500/MB500P

DIGITAL BALANCING MACHINE WITH INNOVATIVE FUNCTIONS



MB500/MB500P DIGITAL BALANCING MACHINE WITH INNOVATIVE FUNCTIONS

- 🇬🇧 M&B MB500/500P is the versatile digital balancing machine with innovative functions
- 🇮🇹 M&B MB500/500P è l'equilibratrice digitale versatile dalle funzioni innovative
- 🇫🇷 M&B MB500/500P est l'équilibreuse de roue numérique polyvalente avec fonctions innovantes
- 🇩🇪 M&B MB500/500P erhältlich ist die digitale vielseitig Auswuchtmaschine mit innovativen Funktionen
- 🇪🇸 M&B MB500/500P es la equilibradora de ruedas digital versátil con funciones innovadoras







INNOVATIVE SOFTWARE



AUTOMATIC APPROACH to the correction position

Once the measuring launch is completed, the wheel automatically stops close to the exact point of application of the counterweight, allowing the operator to position it correctly with a little movement. So it facilitates and speeds up the calibration procedure.

After the first plane correction, pressing "start" the wheel will be repositioned around the second correction point

-  **Automatic gauge** for a correct measurement of distance and diameter
Sonar system for automatic detection of rim width
Display panel with immediate interface to ease the operation
Laser line for the correct application of stick-on weights
Automatic approach: automatic wheel stop close to the points of application of correction weights and electric brake to lock the wheel in position
Intuitive and user-friendly **SPLIT, OPT, ALU programs**
Work optimisation thanks to reduced balancing times
Wheel protection guard that allows balancing of 1.120 mm (40") diameter wheels
MB500P: pneumatic wheel locking which grants floor to floor time reduction and accurate wheel centering
-  **Calibro automatico** per la corretta misura di distanza e diametro
Sistema Sonar per la rilevazione automatica della larghezza cerchio
Pannello display con interfaccia immediata per facilitare le operazioni
Linea laser per la corretta applicazione del peso adesivo
Avvicinamento automatico: arresto automatico della ruota in prossimità dei punti di applicazione del peso di correzione e freno di stazionamento elettrico
Programmi SPLIT, OPT, ALU intuitivi e di facile utilizzo
Ottimizzazione del lavoro grazie ai tempi di equilibratura ridotti
Carte di protezione ruota che permette l'equilibratura di ruote aventi un diametro di 1.120 mm (40")
MB500P: fissaggio della ruota con **bloccaggio pneumatico** che garantisce una riduzione dei tempi di montaggio ed una maggiore precisione nel centraggio della ruota
-  **Calibrage automatique** pour la mesure correcte de la distance et du diamètre
Système sonar pour la détection de la largeur de la jante
Panneau d'affichage avec interface immédiate pour faciliter les opérations
Indicateur laser de positionnement du poids adhésifs
Approche automatique: arrêt automatique de la roue près du points d'application du poids de correction et frein électrique pour bloquer la roue
Programmes SPLIT, OPT, ALU intuitifs et faciles à utiliser
Optimisation du travail grâce aux temps d'équilibrage réduits
Carte de protection de la roue permettant l'équilibrage de roues ayant un diamètre de 1.120 mm (40")
MB500P: verrouillage de la roue par **blocage pneumatique**, ce qui garantit une réduction des temps de montage et une haute précision du centrage de la roue
-  **Automatischer Messlehre** zur korrekten Messung von Abstand und Durchmesser
Sonarsystem zur Erfassung der Felgenbreite
Anzeigefeld mit sofortiger Benutzeroberfläche zur Erleichterung der Bedienung
Laserstrahl zur Positionierung des Klebegewichtes
Automatischer Ansatz: automatischer Radstopp in der Nähe des Gewichtsanwendungspunkts und Elektrische Bremse zum Blockieren des Rads
Intuitive und benutzerfreundliche **SPLIT-, OPT- und ALU-Programme**
Arbeitsoptimierung durch verkürzte Auswuchtzeiten
Instandhaltung **Radabdeckung** die das Wuchten von Reifen bis zu einem Durchmesser von 1.120 mm (40") erlaubt
MB500P: pneumatische Radaufspannung, die eine Verkürzung der Montagezeiten und eine hohe Genauigkeit bei der Radzentrierung garantiert
-  **Calibre automático** para una medición correcta de distancia y diámetro
Sistema sonar para detectar el ancho de la llanta
Panel pantalla con interfaz inmediata para facilitar las operaciones
Linea laser para el posicionamiento exacto de los contrapesos adhesivos
Enfoque automático: parada automática de la rueda cerca de los puntos de aplicación de los pesos de corrección y freno eléctrico para bloquear la rueda y facilitar la aplicación de los contrapesos
Programas SPLIT, OPT, ALU intuitivos y de uso fácil
Optimización del trabajo gracias a los tiempos reducidos de equilibrado
Cárter de protección de la rueda que permite el equilibrado de ruedas con 1.120 mm de diámetro (40")
MB500P: apriete de la rueda con **bloqueo neumático**, lo que garantiza tiempos de montaje reducidos y una mayor precisión al centrar la rueda

STANDARD CONFIGURATION



OPTIONAL ACCESSORIES

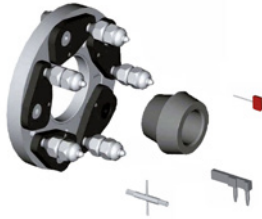

UH20/2 Ø 40
Universal adapter 3-4-5-6 hole



RL cup Ø 40
with rubber ring for alloy rims protection

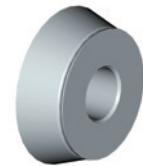

J cone Ø 40
for cross-country and
4WD wheels range Ø 101-119 mm



WD spacer Ø 40
(Spacer for wide wheels) + DC spacer
Ø 40 (to use together with WD)



VL/2 cone Ø 40
Large cone for light truck 97-180 mm



Special cone Ø 40 for central
hole Ø 89/132 mm



ZERO WEIGHT
Professional automatic wheel lift
capacity 80 kg

OVERALL DIMENSIONS

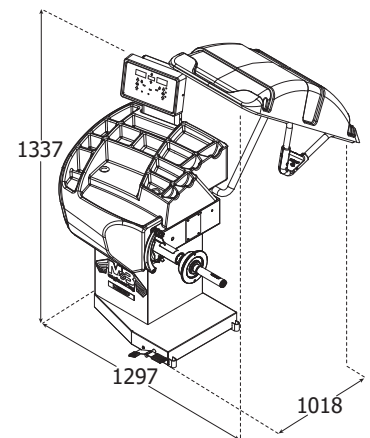
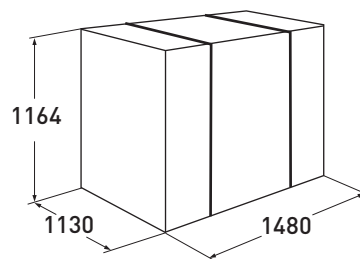

TECHNICAL DATA

120 kg	10" ÷ 30" 265 ÷ 765 mm	1.5" ÷ 20" 40 ÷ 510 mm	20" 508 mm	40" 1120 mm	< 75 kg	230V/1/50-60 Hz 115V/1/60 Hz	100 rpm	0,15



M&B ENGINEERING SRL
Via Nobel, 21 - 42124 Reggio Emilia (RE)
info@mb-re.it - www.mbenengineering.info