





-  **SMONTAGOMME SEMIAUTOMATICI**
-  **SEMI-AUTOMATIC TYRE CHANGERS**
-  **HALBAUTOMATISCHE REIFENMONTIERGERÄTE**
-  **DEMONTE-PNEUS SEMI-AUTOMATIQUES**
-  **DESMONTADORAS SEMI-AUTOMÁTICAS**

- Robusta struttura portante per garantire in ogni situazione la corretta condizione di lavoro.
- Cilindro zincato a doppio effetto.
- Mandrino autocentrante di elevata rigidità e notevole campo di serraggio.
- *Heavy duty structure to guarantee proper working conditions at all times.*
- *Galvanised cylinder with double operation.*
- *Rigid self-centering chuck and wide clamping range.*
- Robuste Tragstruktur für einwandfreie Arbeitsbedingungen in jeder Situation.
- Mit verzinktem Kolben und doppelwirkend.
- Selbstzentrierende Spannvorrichtung, sehr starr, grosser Arbeitsbereich.
- *Robuste structure portante pour garantir en toute situation des bonnes conditions de travail.*
- *Cylindre zingué, à effet double.*
- *Mandrin autocentreur de haute rigidité et vaste plage de serrage.*
- Robusta estructura portante para garantizar la correcta condición de trabajo en cualquier situación.
- Cilindro cincado, de simple efecto.
- Mandril autocentrador de gran rigidez y considerable campo de fijación.

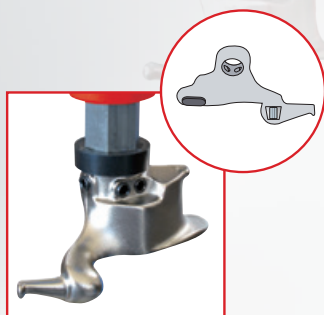

Utensile con protezione integrata per cerchi in lega.

*Tool with intergrated protection for alloy rims.*

Montagekopf mit Alufelgenschutz.

*Outil avec protection intégrée pour jantes en alliage.*

Útil con protección integrada para llantas de aluminio.



In configurazione FI (gonfiaggio rapido per pneumatici tubeless), è equipaggiata di dispositivo di gonfiaggio a pedale completo di valvola di gonfiaggio e manometro

*In FI configuration (quick inflation for tubeless tyres) it is equipped with pedal-operated inflation device complete with inflator valve and pressure gauge.*

Besitzt in der FI-Version (mit Schnellbefüllung für schlauchlose Bereifung) einen komplettem Pedal-Reifenbefüller mit Befüllungsventil und Manometer.

*En configuration FI (gonflage rapide pour pneus sans chambre), elle est équipée de dispositif de gonflage à pédale avec soupape de gonflage et manomètre.*

Con la configuración FI (inflado rápido para neumáticos tubeless), está equipada con dispositivo de inflado a pedal con válvula de inflado y manómetro.

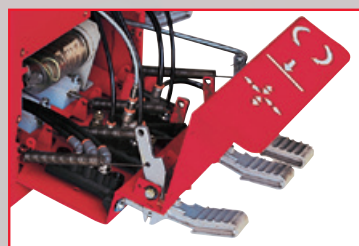

Fornita con pedaliera estraibile per consentire una facile manutenzione

*Supplied with removable pedal unit for easy maintenance.*

Die ausziehbare Pedalsteuerung erleichtert die Wartungsarbeiten.

*Dotée de pédalier extractible pour faciliter les interventions de maintenance.*

Suministrada con pedales extraíbles para permitir un mantenimiento sencillo.

## OPTIONS



### PLUS 91N

Dispositivo premitalone e solleva-pneumatico per operare su ruote difficili o di grandi dimensioni.

*Bead top pressing and tyre lifting device for large and special tyres.*

Wulstdrück- und Reifenhebevorrichtung für Arbeiten an schwierigen und großen Rädern.

*Dispositif pousse-talon et de levage du pneu permettant d'opérer sur des roues difficiles ou de grandes dimensions.*

Dispositivo presiona talón y levanta- neumático para trabajar con ruedas difíciles o de tamaño grande.



### G800A96

Pistola di gonfiaggio rapido con limitatore  
Quick inflation gauge with pressure regulator  
Schnell Reifenluftdruck-Prüfgerät mit Druckventil  
Pistolet de gonflage rapide avec limiteur de pression  
Pistola de inflado rapido con limitador de presión

## PROTECTIONS



G800A98 (4 x Kit)

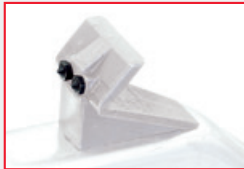

G800A122 (8 x kit)  
G800A122K (40 x kit)  
Punte sostituibili  
*Renewable spikes*  
Austauschbaren Haltekörner  
*Pointes remplaçables*  
Puntas reemplazables



G800A11  
G800A11K (5 x kit)



G800A117 (2 x kit) QUICK INSERT  
G800A117K - Kit 10 x G800A117

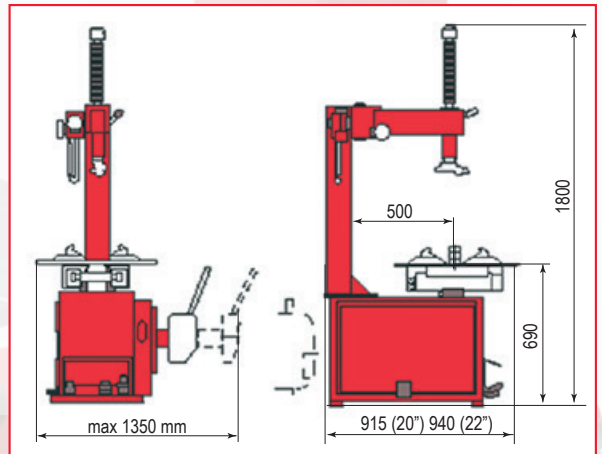

DATI TECNICI	TECHNICAL DATA	TECHNISCHE DATEN	DONNES TECHNIQUES	DATOS TÉCNICOS	PC 240.20	PC 240.22 PC 240.22FI
Aggrappamento interno	Inner clamping	Spannbereich innen Zoll	Blocage de l'intérieur	Sujeción interior	12"/22,5"	13"/24,5"
Aggrappamento esterno	Outer clamping	Spannbereich außen Zoll	Blocage de l'extérieur	Sujeción exterior	10"/20"	11"/22"
Diametro max ruota	Max wheel diameter	Max. Raddurchmesser	Diametre max du pneu	Diám. máx.de la rueda	1030 mm (40,5")	
Larghezza max ruota	Max wheel width	Max. Radbreite	Largeur max du pneu	Max anchura rueda	12"	
Forza di stallonamento	Bead breaker force	Abdrückkraft	Force de décoll. du talon	Fuerza de destalonam.	3600 kg (8000 lbs)	
Motore elettrico	Electric motor	Elektrische motor	Moteur électrique	Motor electrico	0,55 kW	
Velocità di rotazione	Rotation speed	Drehgeschwindigkeit	Vitesse de rotation	Velocidad de rotación	7,3 rpm	
Coppia max del piatto	Max torque turntable	Max sperrvorr.drehmom.	Couple max au mandrin	Par max al mandril	1200 Nm (885 Ft/L lbs)	

# Butler

Engineering and Marketing S.p.A. a.s.u.  
Via dell'Ecologia 6 - 42047 Rolo (RE)  
Ph. +39-0522-647911 - Fax +39-0522-649760  
www.butler.it - info@butler.it

A DOVER COMPANY

DBN16U (06)

Le caratteristiche tecniche e gli allestimenti presentati in questo prospetto possono subire variazioni. Le immagini riprodotte non sono vincolanti.

*Technical data and composition presented in this catalogue may vary. Pictures reproduced are only indicative.*

Die techn. Daten und die Ausrüstungen, die in diesem Prospekt enthalten sind, können Änderungen erfahren. Deshalb sind die Abbildungen unverbindlich.

*Les caractéristiques techniques et les compositions présentées dans ce prospectus peuvent subir des variations. Les images reproduites n'ont qu'une valeur indicative.*

Las características técnicas y las composiciones ilustradas en este folleto pueden sufrir variaciones. Las imágenes propuestas son solamente indicativas.